

### Cilindro

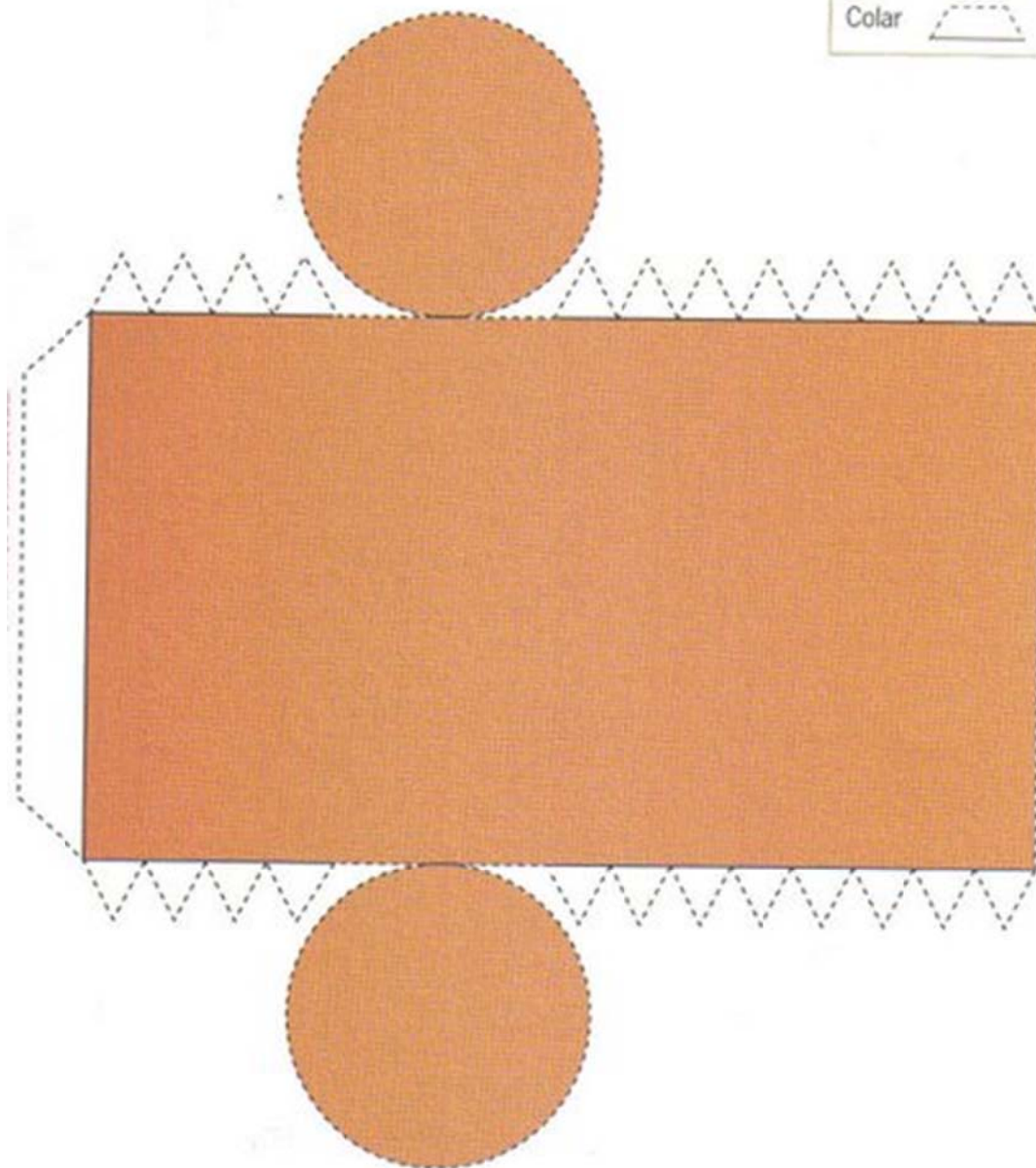

# Cone

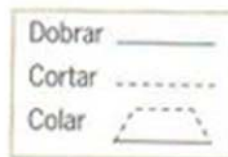
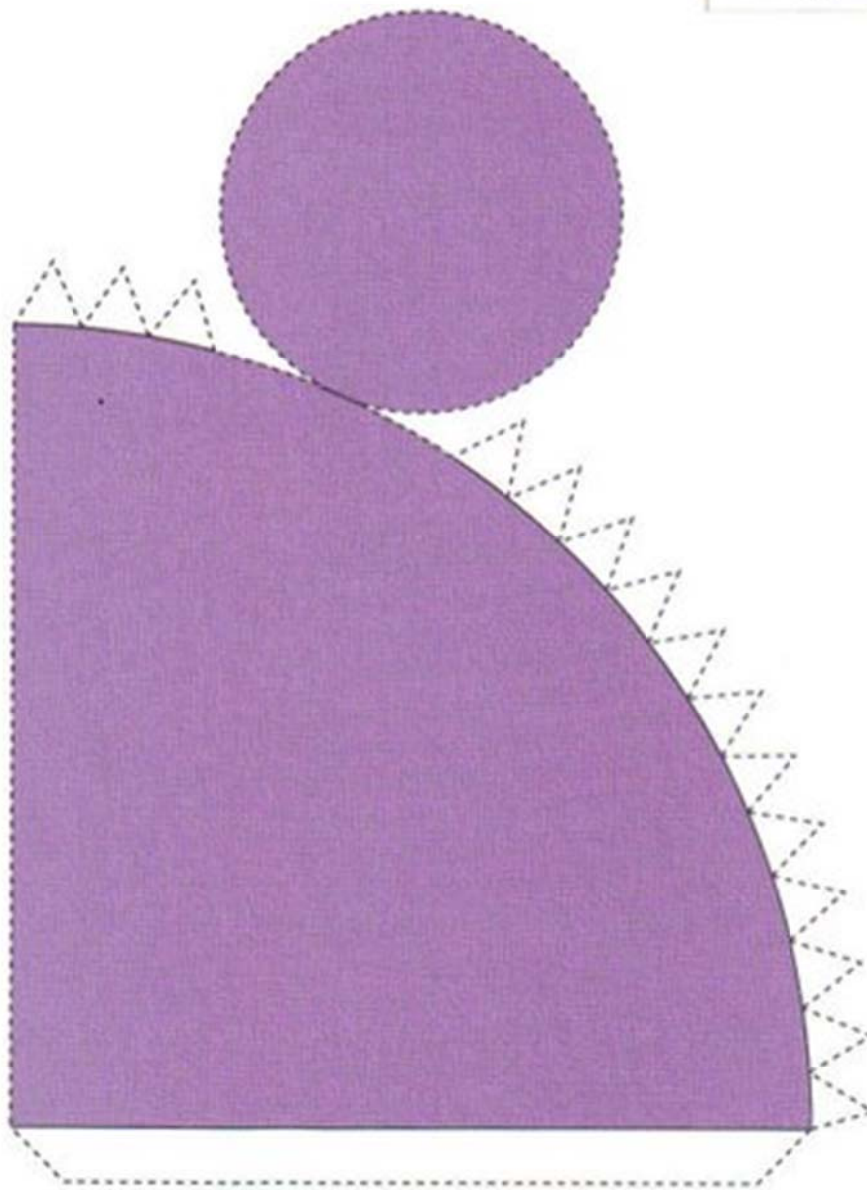
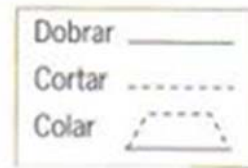

# Cubo

|        |       |
|--------|-------|
| Dobrar | —     |
| Cortar | - - - |
| Colar  | ⌒     |

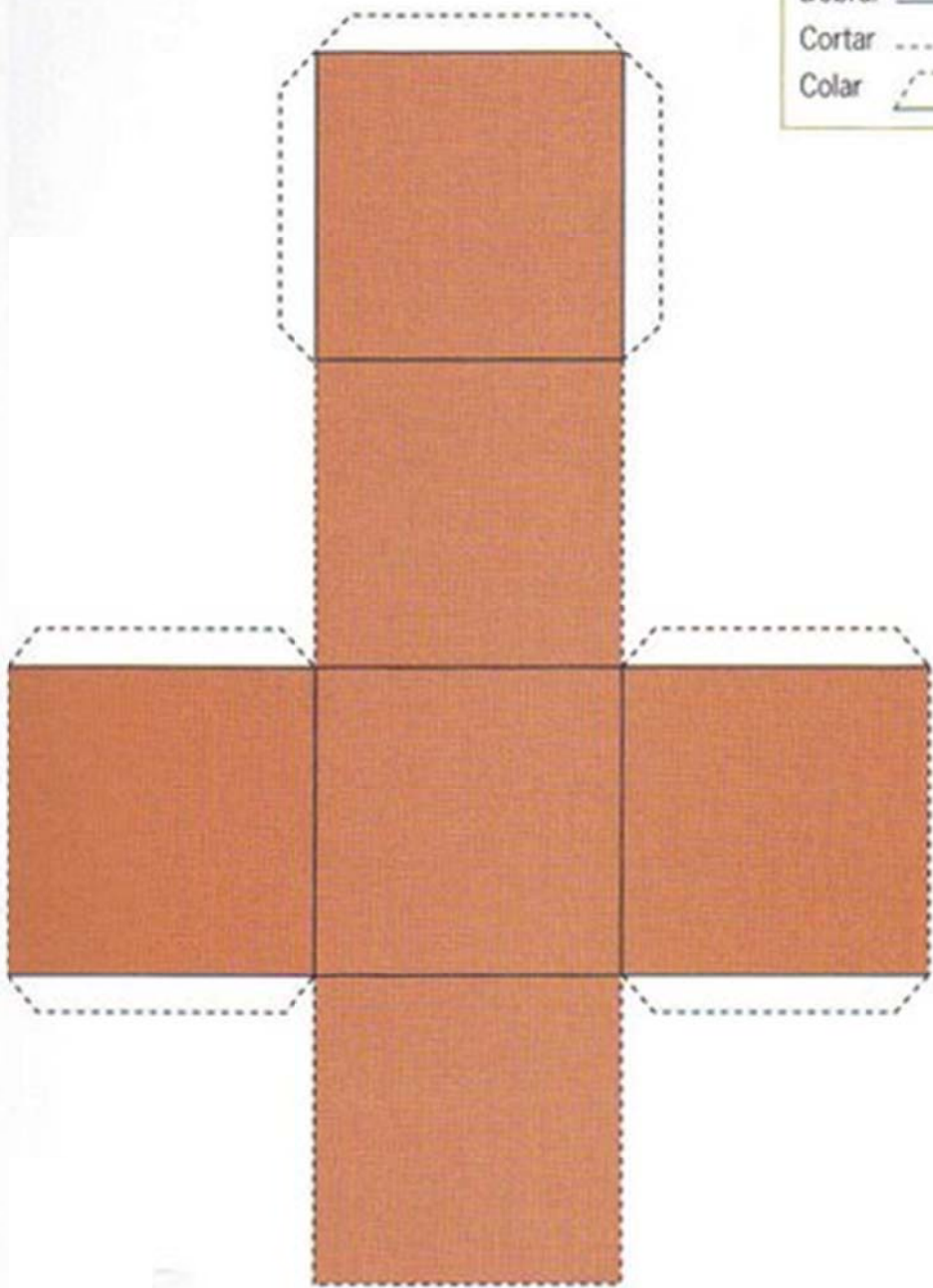

# Dado

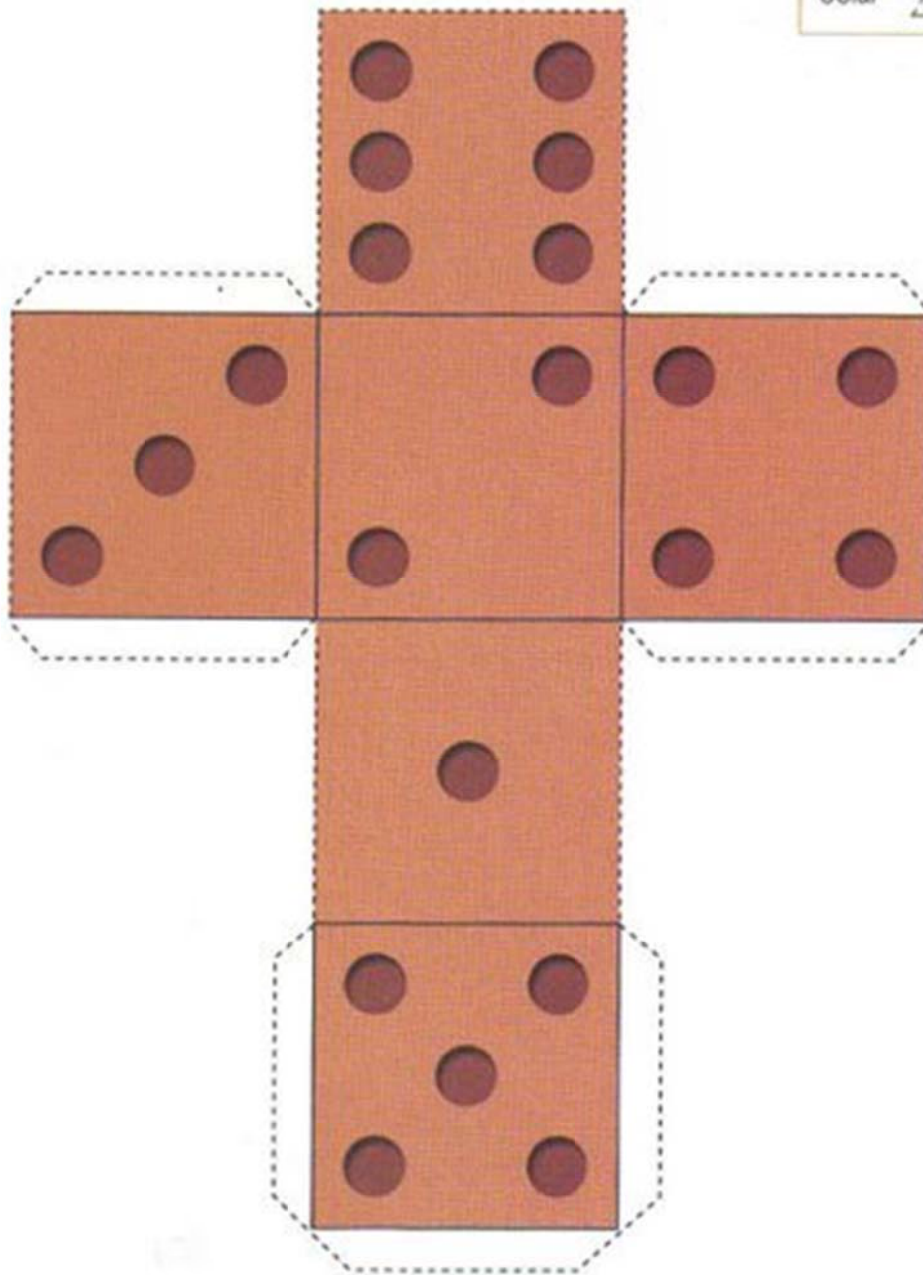
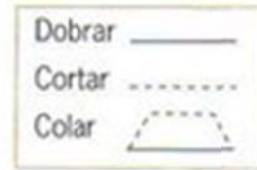

# Paralelepípedo

|        |           |
|--------|-----------|
| Dobrar | ———       |
| Cortar | - - - - - |
| Colar  | ⌒         |

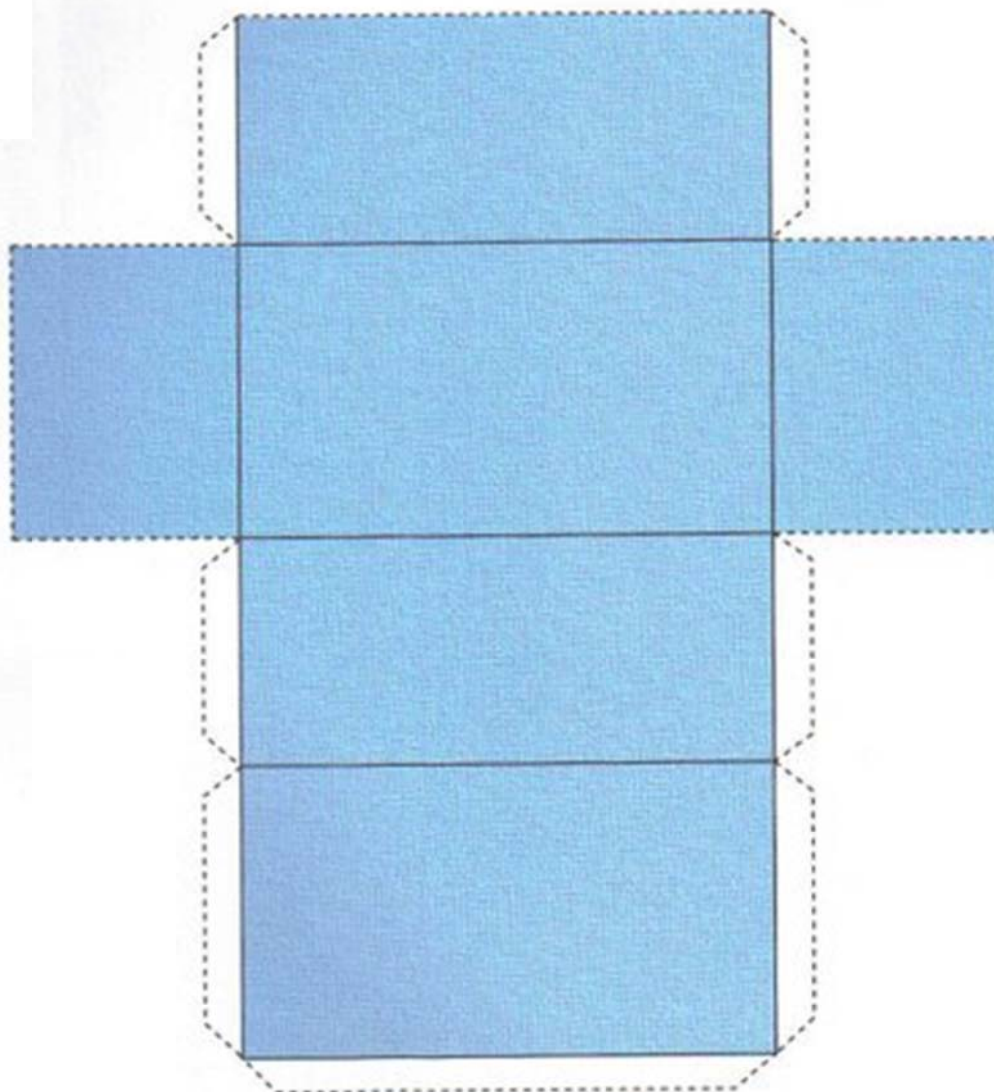



### Pirâmide de base quadrada

|        |           |
|--------|-----------|
| Dobrar | ———       |
| Cortar | - - - - - |
| Colar  | ⌒         |

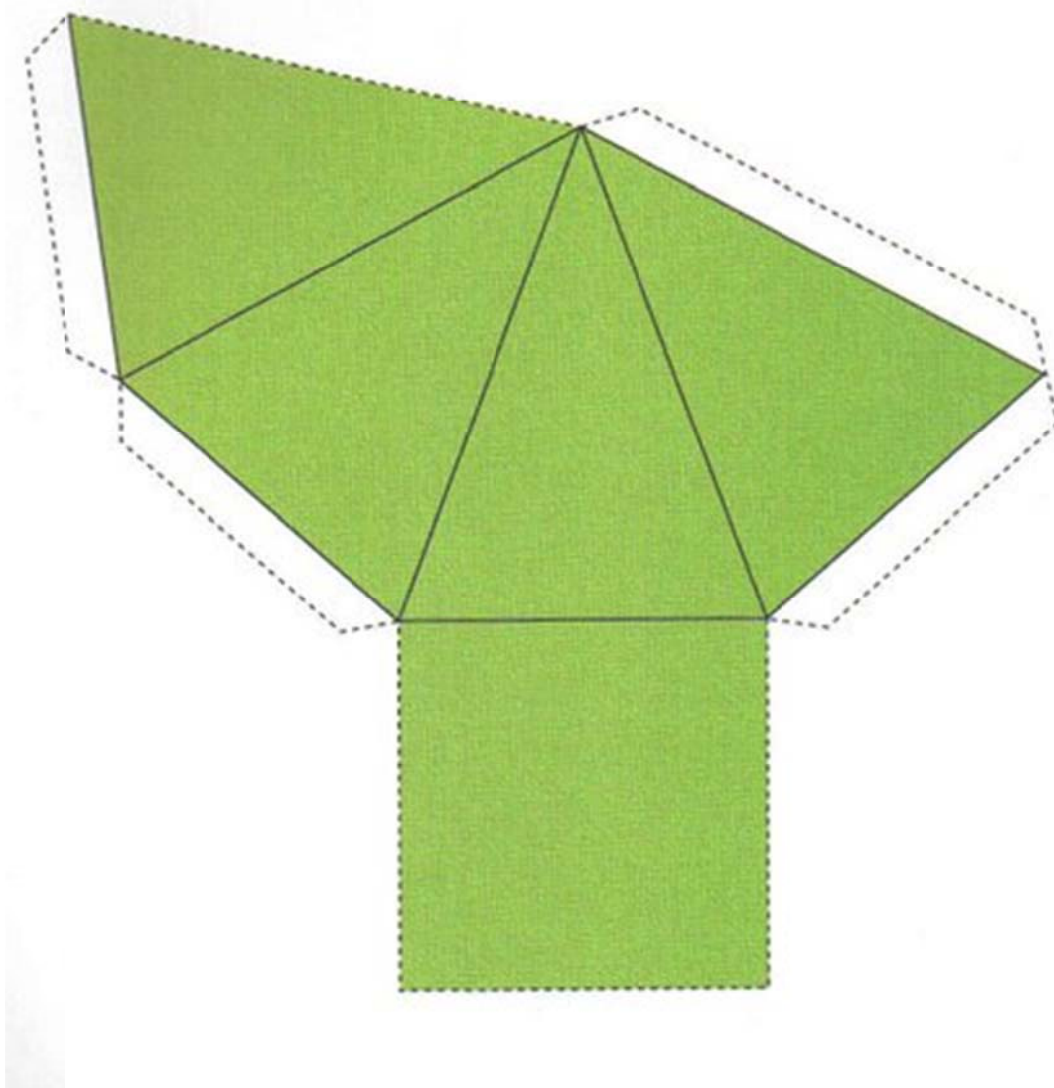

### Prisma de base triangular

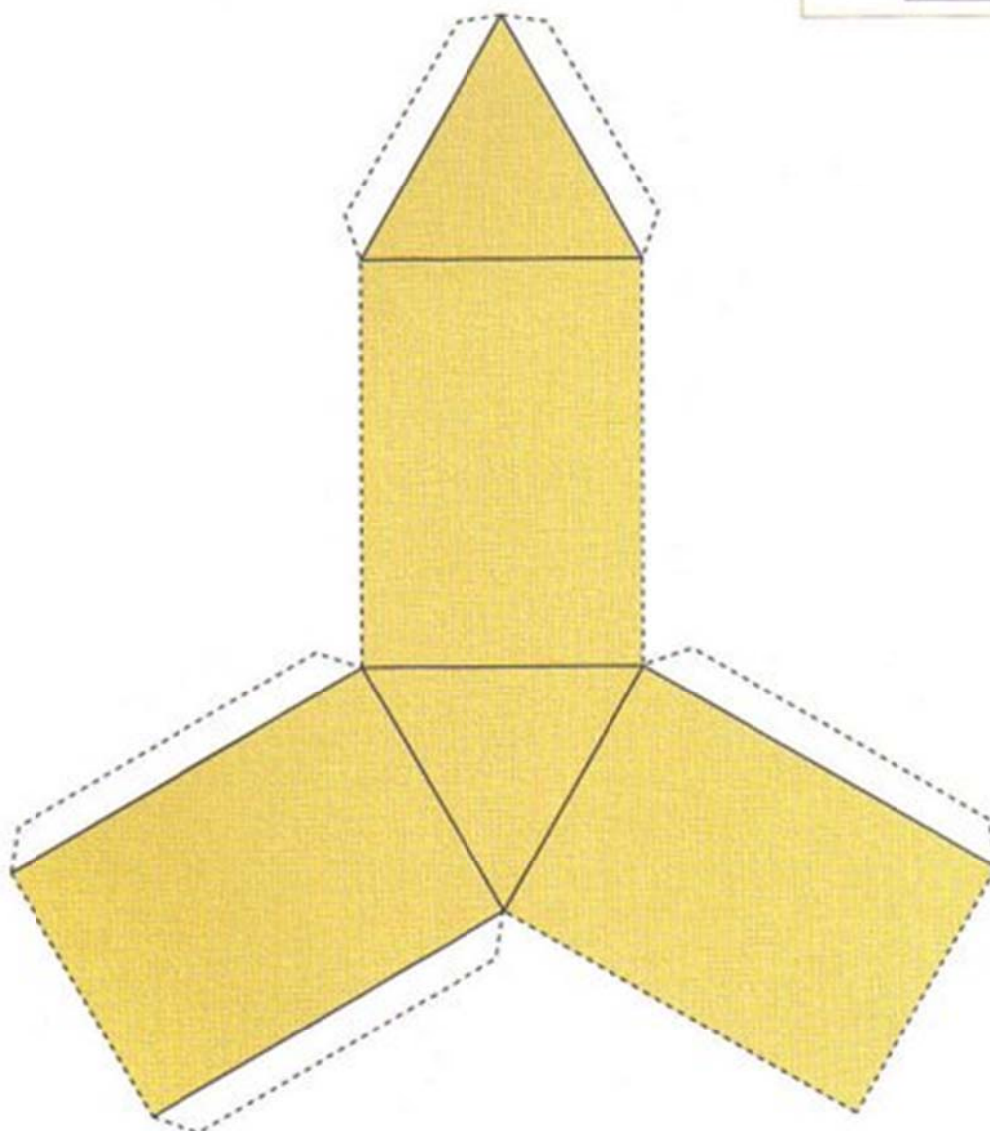
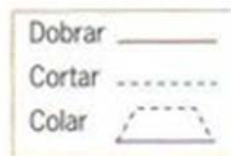

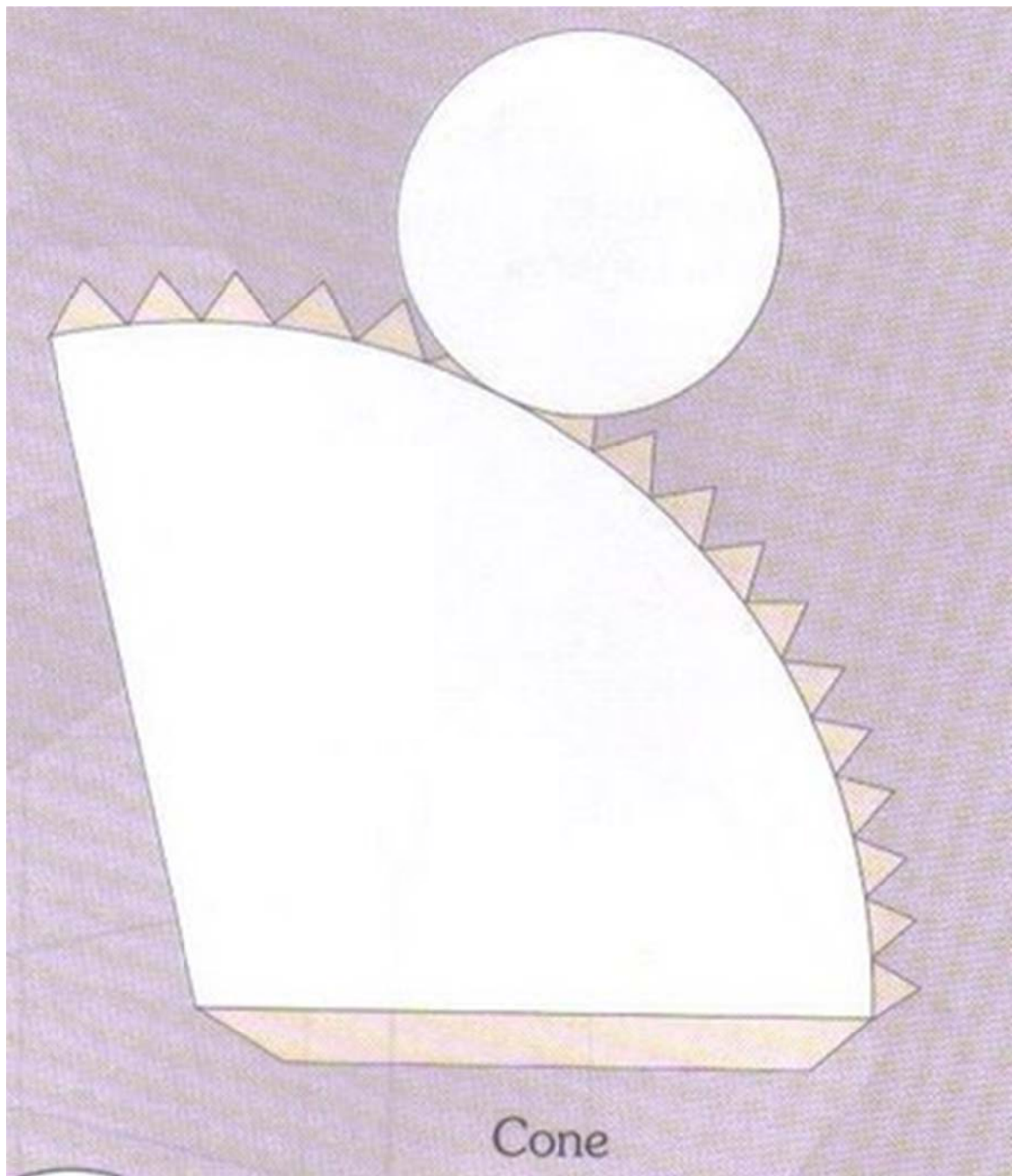



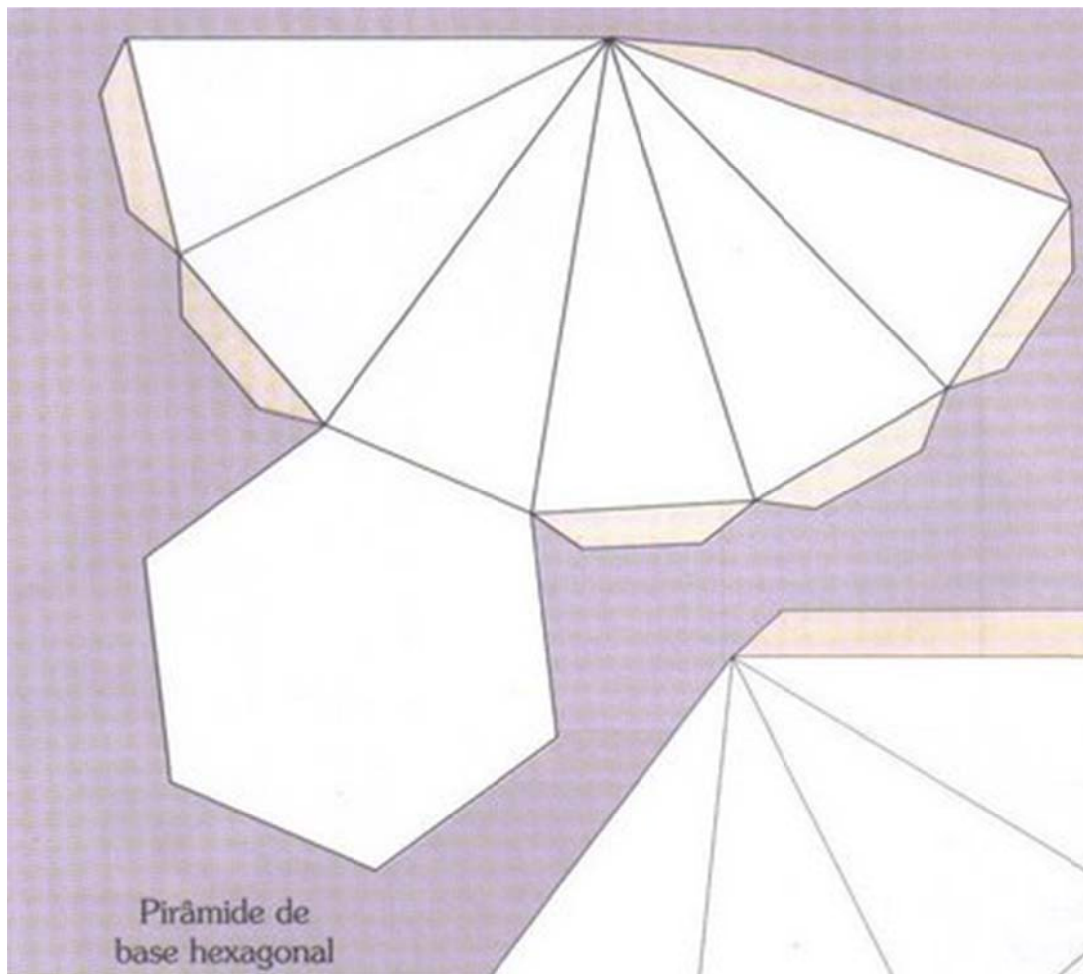

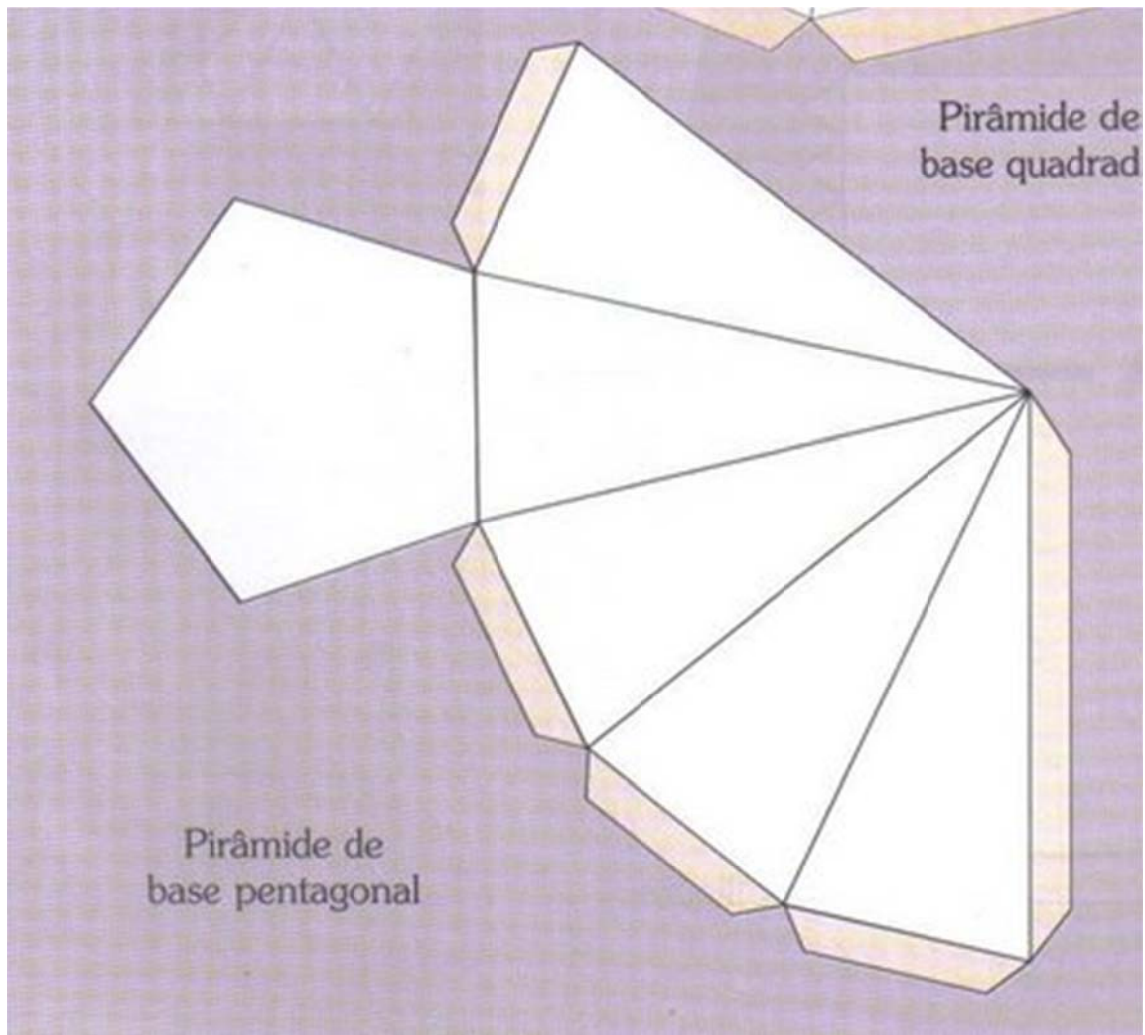

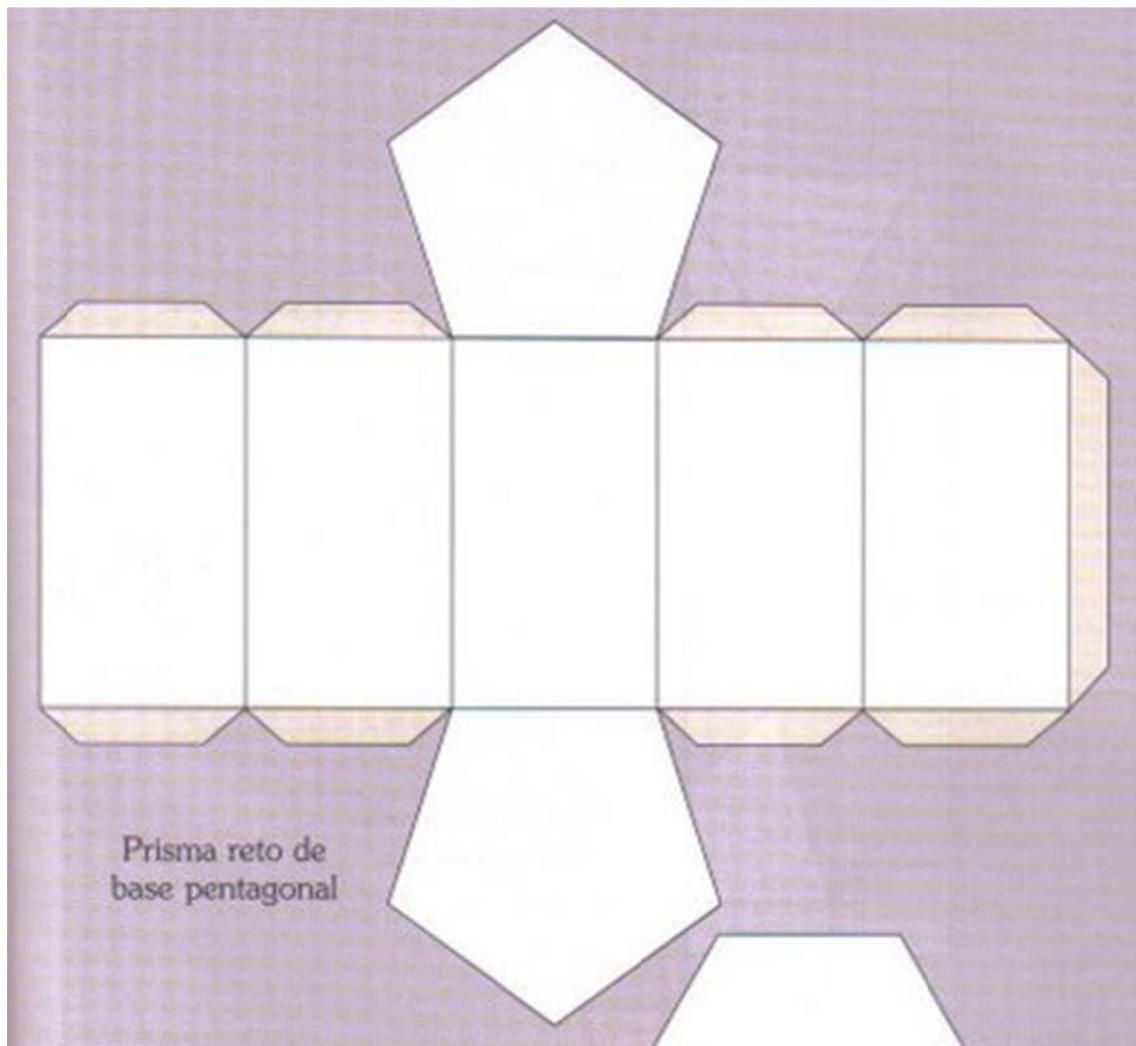

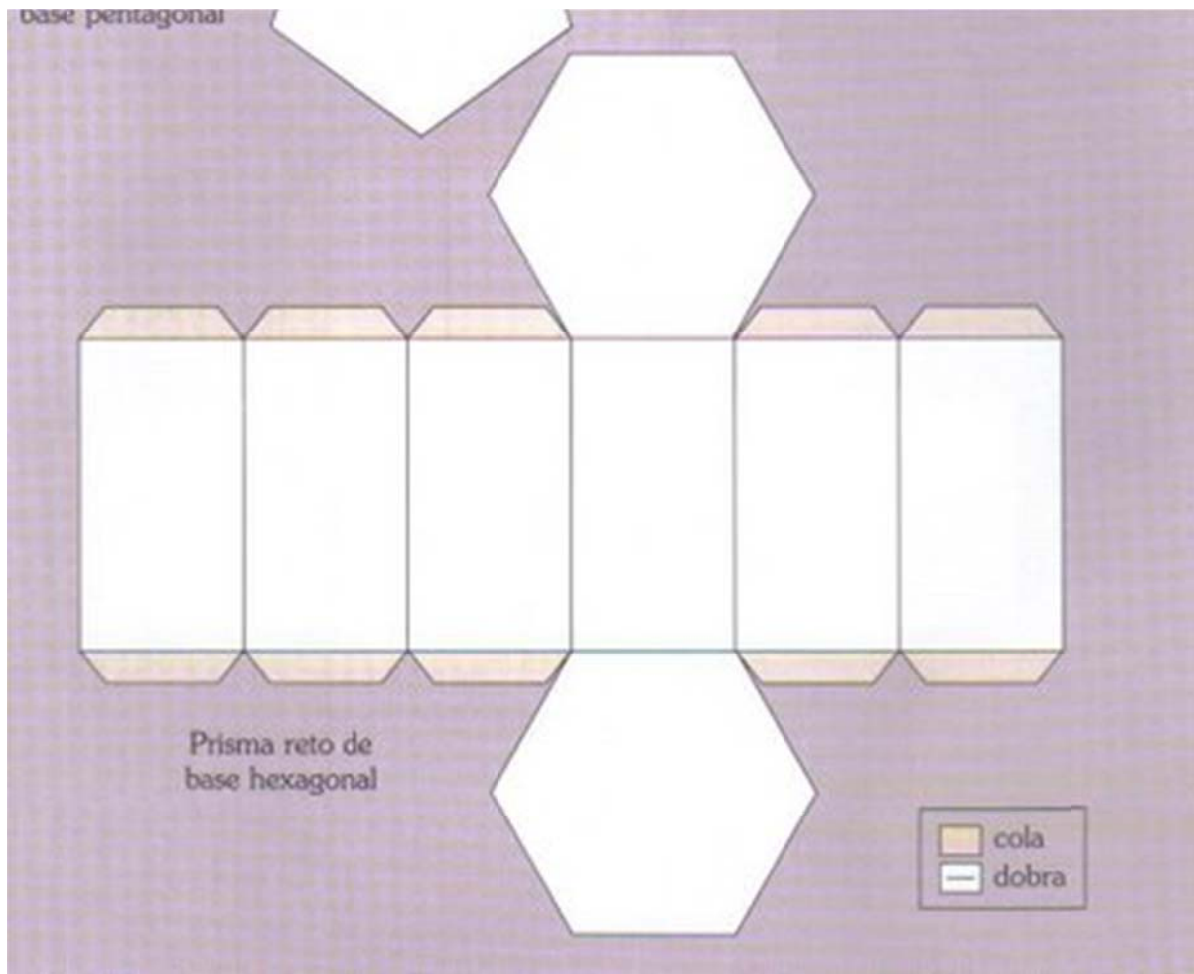



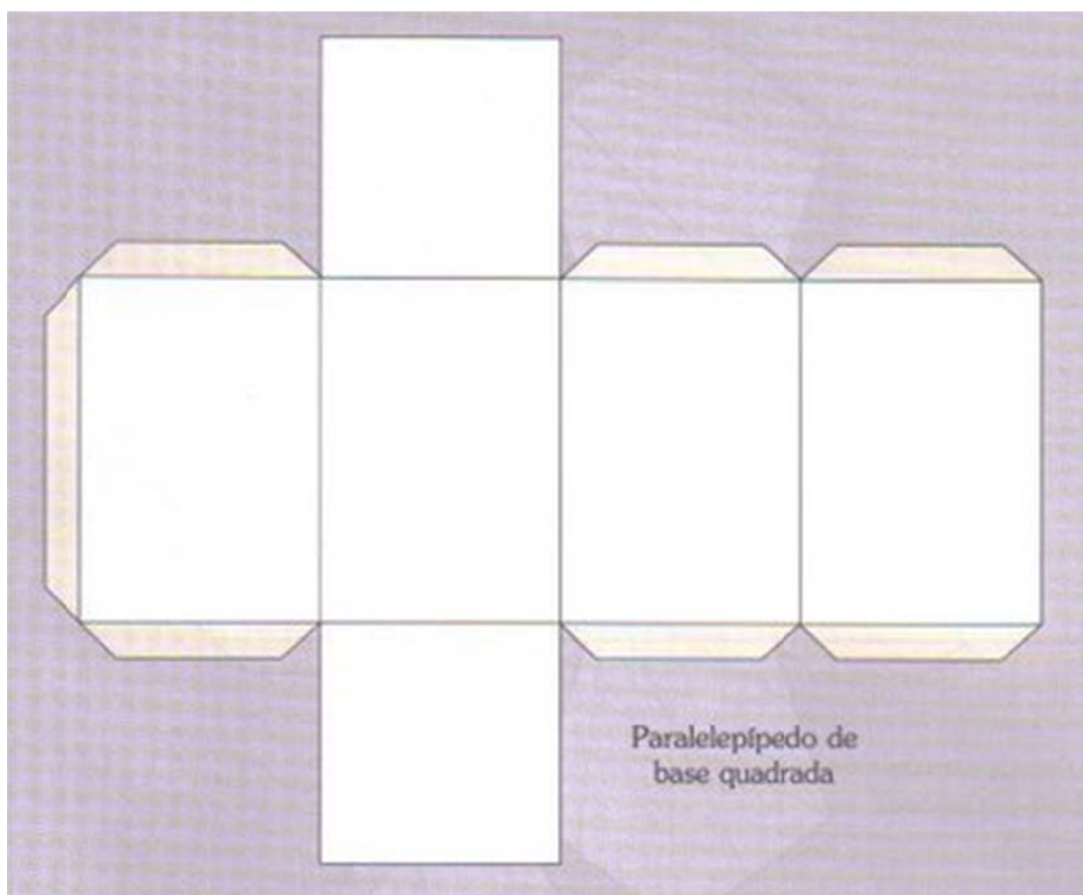
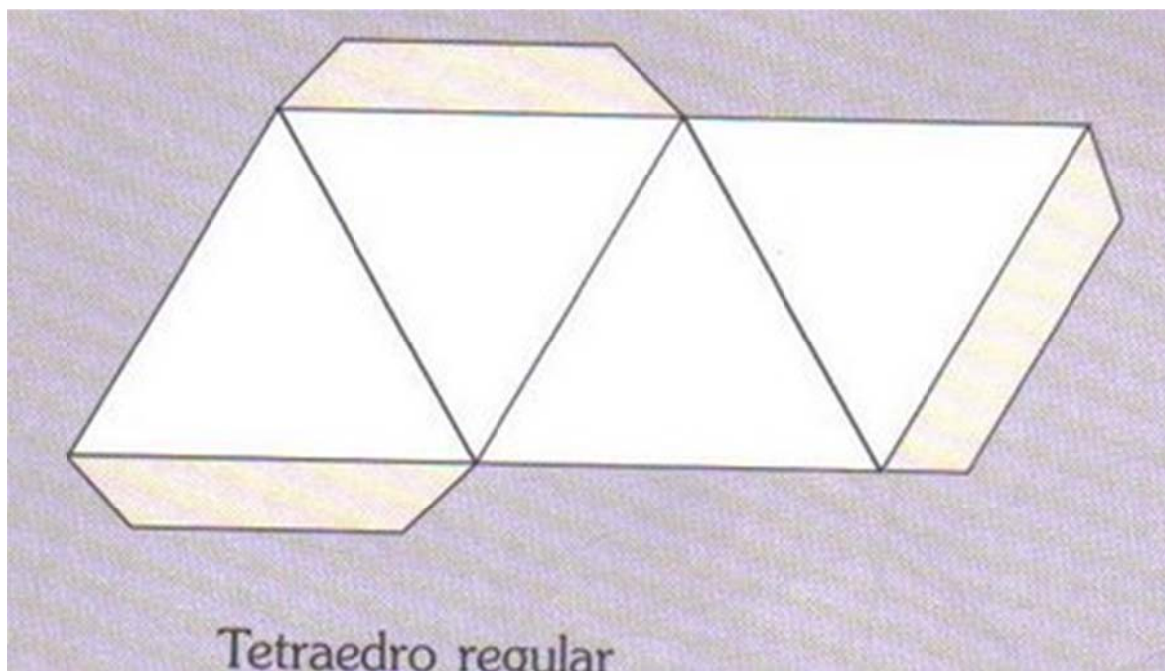

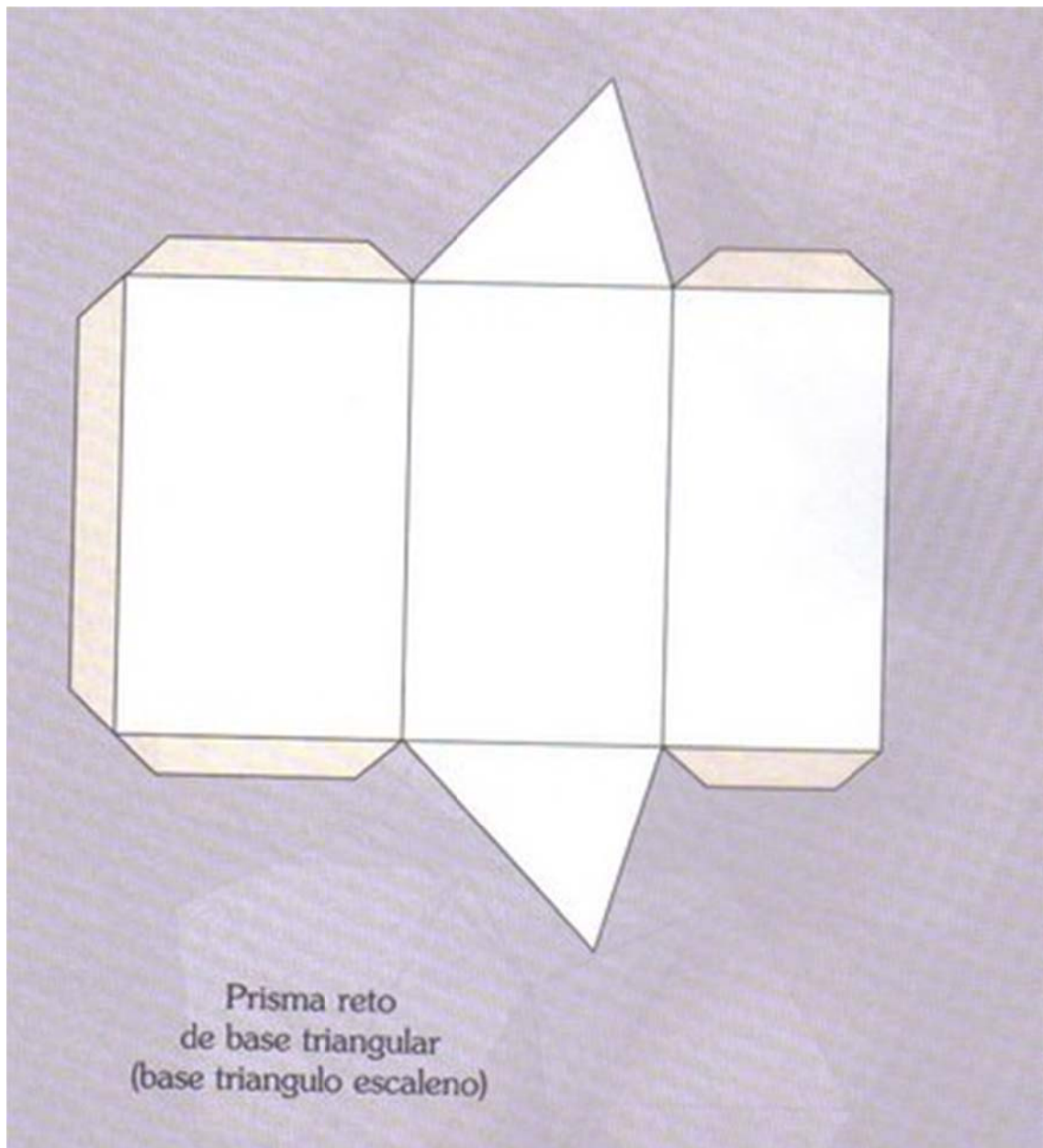

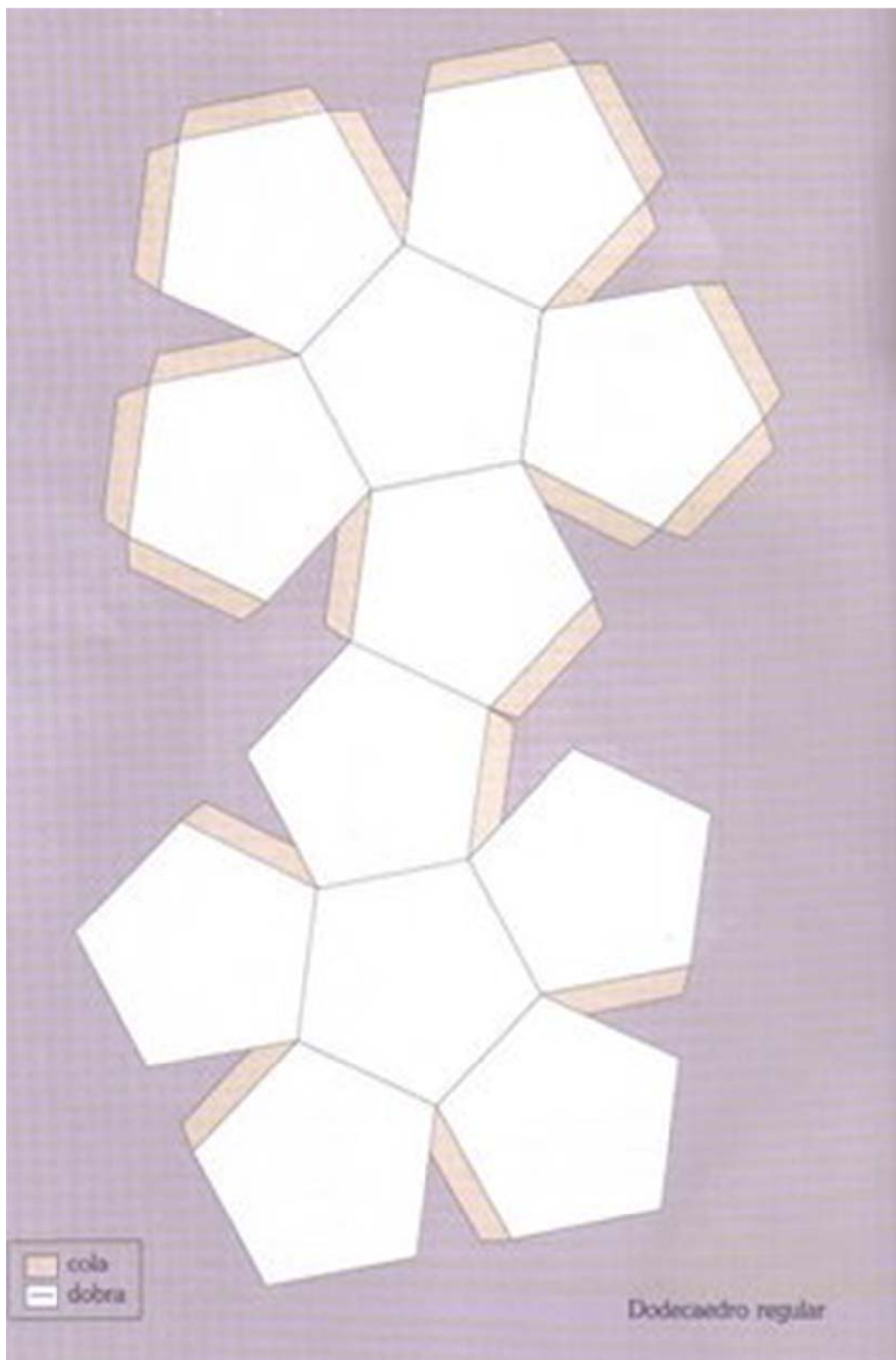

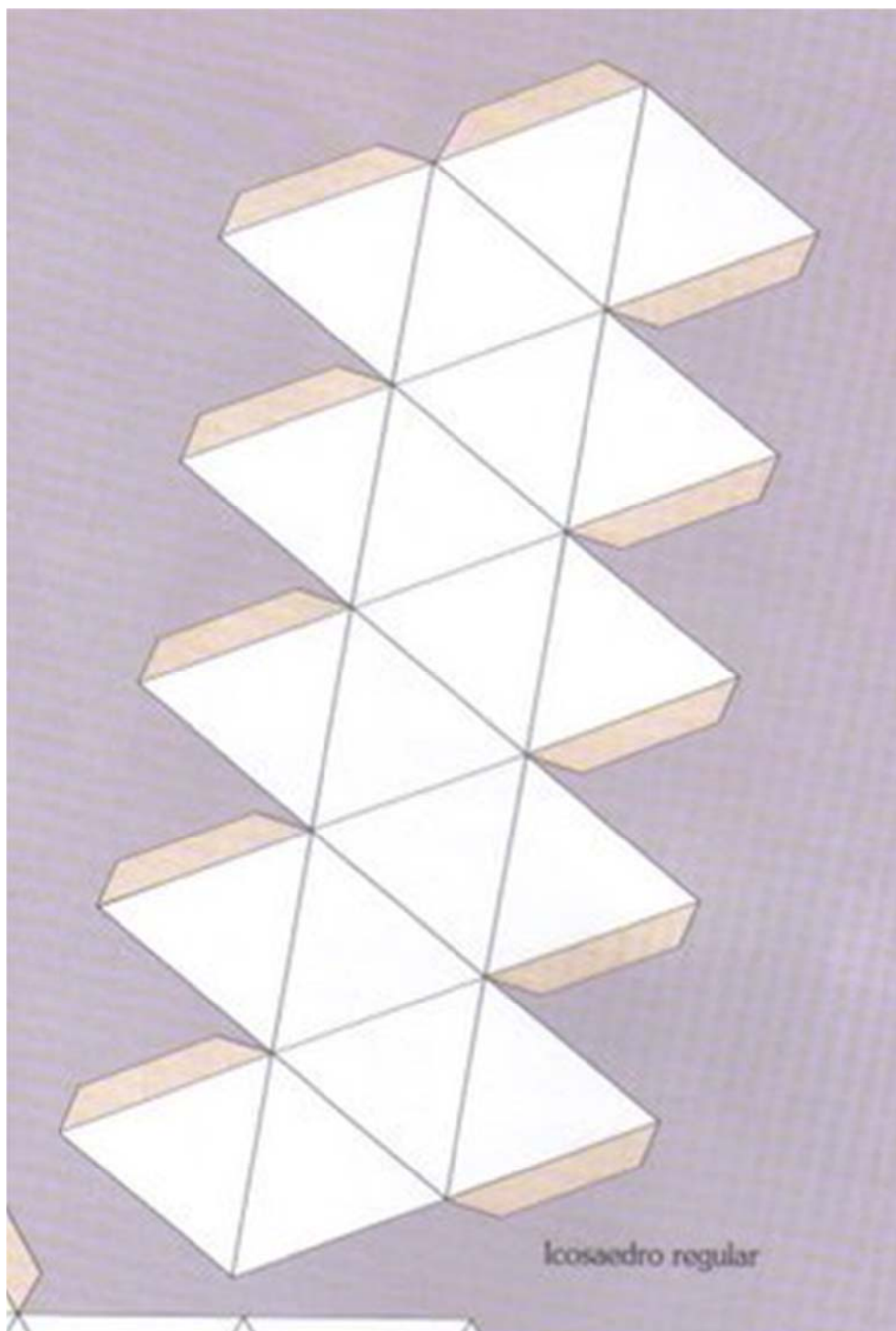





# Molde de um paralelepípedo

 --- cortar

\_\_\_\_\_ dobrar

 colar

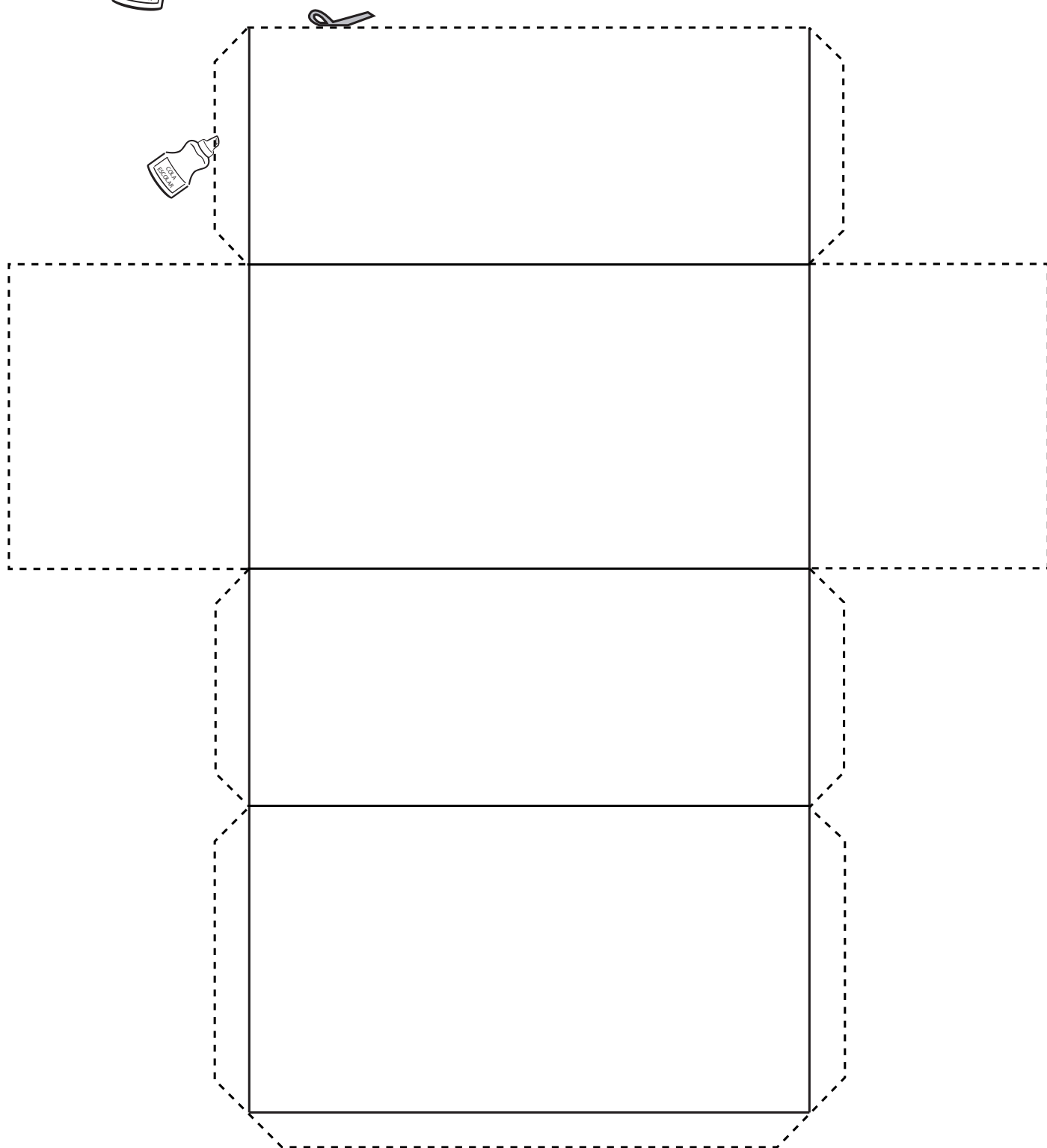

# Molde de um pirâmide de base quadrada

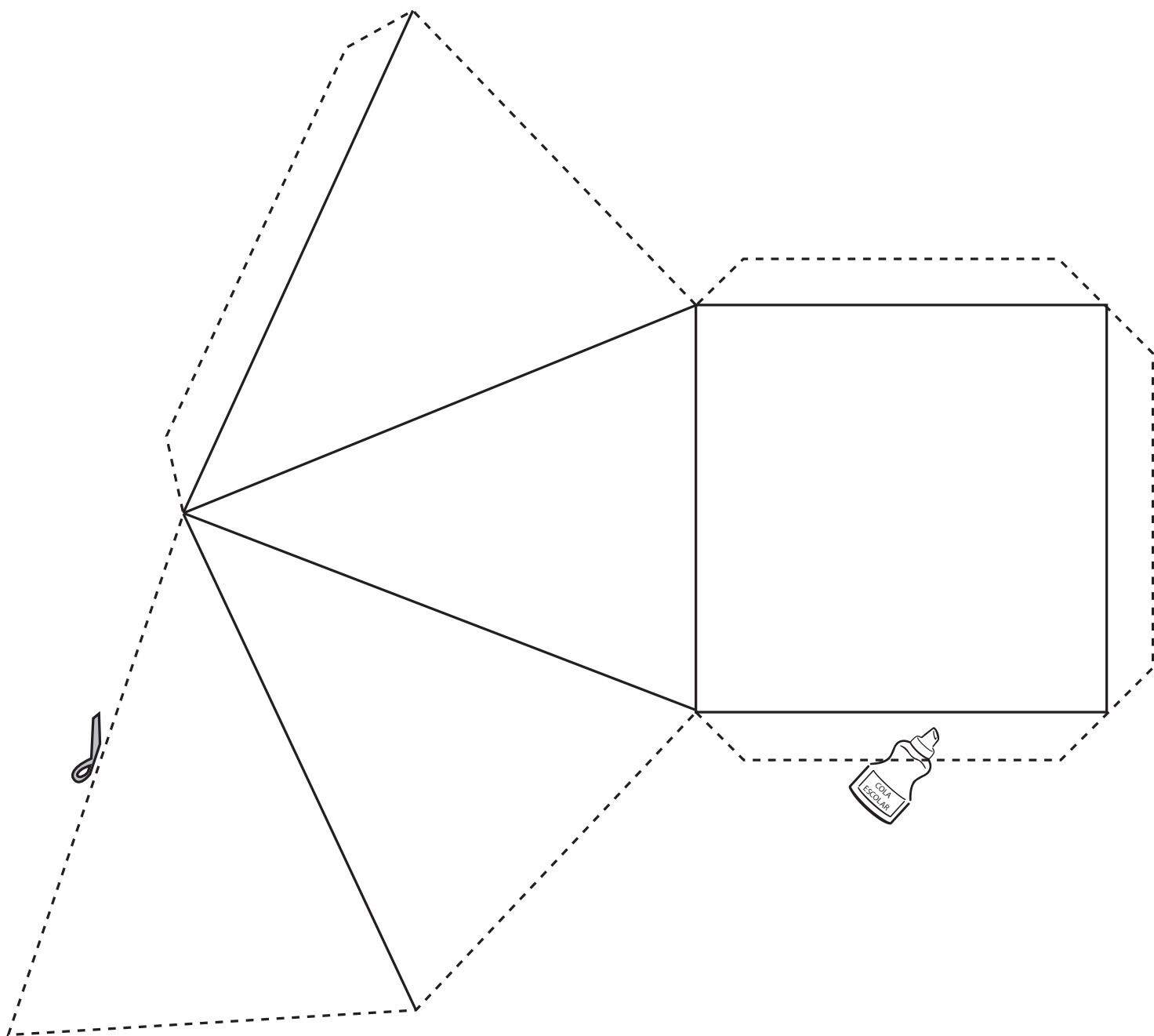

# Molde de um cilindro

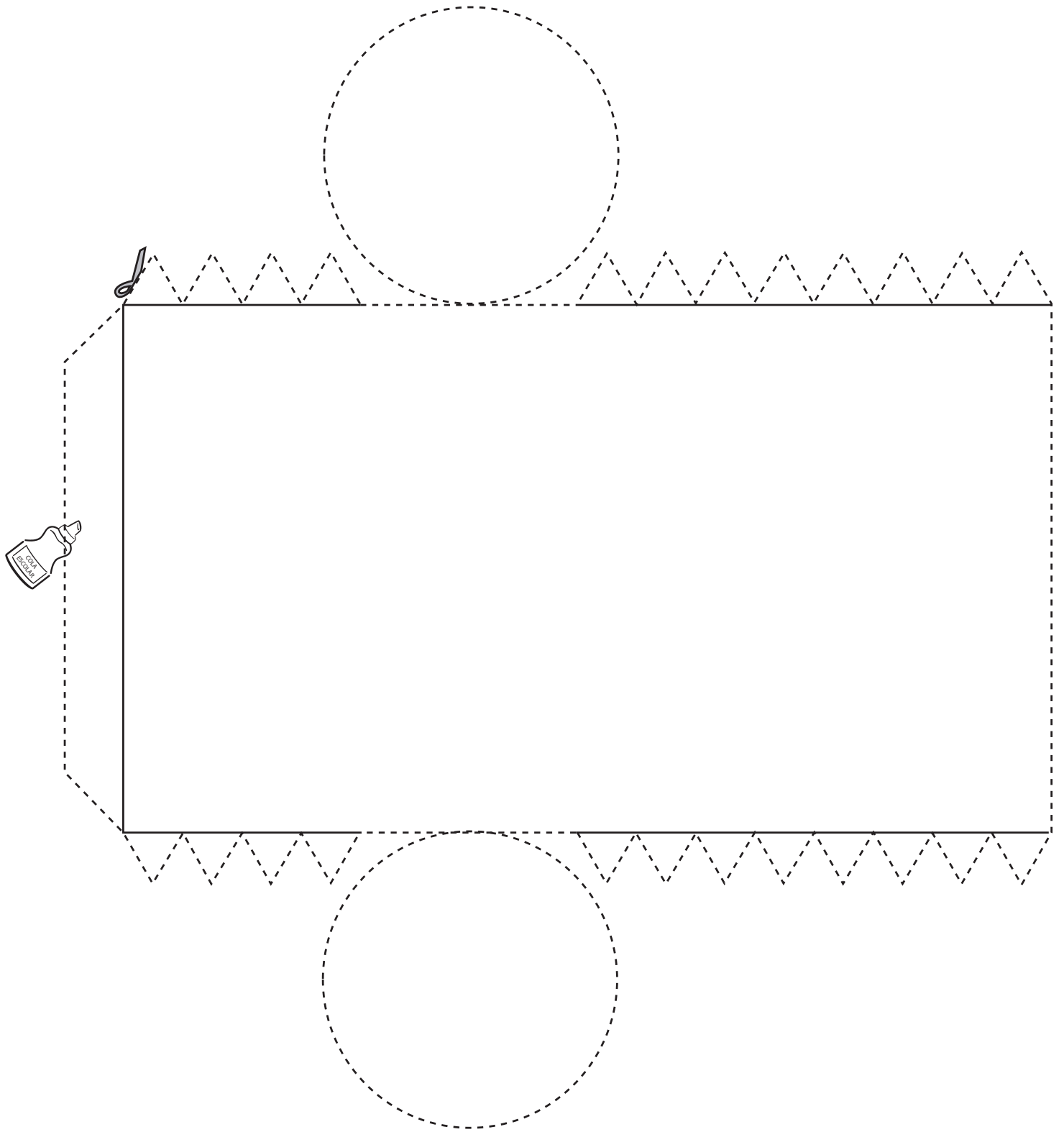

# Molde de um cone

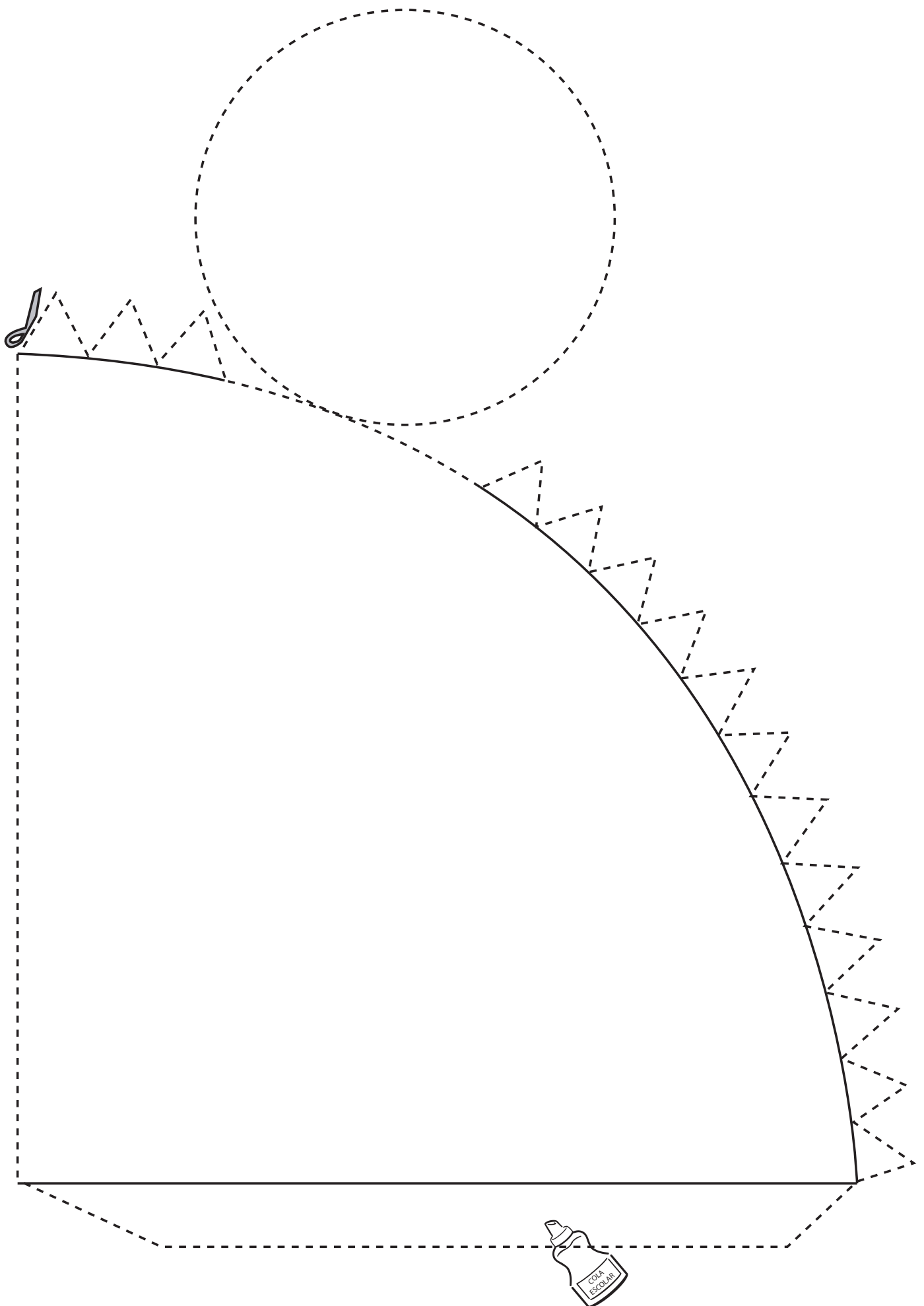



# Molde de um cubo

